

## Basic Fitting and Evaluation Parameters of a Newly Designed Cochlear Implant Electrode

P.R. DEMAN<sup>1</sup>, K. DAEMERS<sup>1,\*</sup>, M. YPERMAN<sup>1,\*</sup>, F.F. OFFECIERS<sup>1</sup>, A. PLASMANS<sup>2</sup>, B. VAN DIJK<sup>2</sup> and P.J. GOVAERTS<sup>1,\*</sup>

From the <sup>1</sup>University ENT Department, St Augustinus Hospital, Antwerp-Wilrijk, Belgium and <sup>2</sup>Cochlear Technology Centre Europe, Mechelen Belgium

**Deman PR, Daemers K, Yperman M, Offeciers FE, Plasmans A, Van Dijk B, Govaerts PJ.** Basic fitting and evaluation parameters of a newly designed cochlear implant electrode. *Acta Otolaryngol* 2003; 123: 1–5.

**Objective**—To validate a newly designed cochlear implant electrode (TRACE) in the standard monopolar mode and compare it to a patient group implanted with a standard Nucleus Contour™ cochlear implant electrode. The electrode contacts of the TRACE electrode have the same active surface area for stimulation, but the position in the scala tympani is different from that of the Nucleus Contour electrode.

**Material and Methods**—The following parameters, used in cochlear implant fitting and evaluation procedures, were determined: the threshold and comfort stimulation current levels; the electrode impedances; and the phoneme discrimination and speech recognition scores using the ACE™ speech algorithm.

### Results

**Conclusion**—The new electrode does not differ significantly from the standard Nucleus Contour electrode in terms of the investigated parameters within the test group.

*Key words:* Nucleus Contour electrode, TRACE electrode.

## INTRODUCTION

Cochlear implants (CIs) are devices that electrically stimulate the auditory nerve fibres in cases of severe to profound sensorineural hearing loss. The implant's electrode is the interface between the electronics and the auditory nerve fibres. It is known that the stimulation efficacy depends on the position and orientation of the electrode contacts with regard to the auditory nerve fibres (1, 2). Over the years different types of electrodes have been designed, with different positions of the metal contacts in the cochlea. In this paper we want to compare a newly designed CI electrode (3), which has electrode contacts oriented towards the basilar membrane (Fig. 1; position y), with a clinically established electrode (Nucleus Contour™), which has electrode contacts focused towards the modiolus (Fig. 1; position x).

The following parameters used in CI fitting and evaluation procedures were examined: (i) the threshold and comfort stimulation current levels; (ii) the electrode impedances; and (iii) the phoneme discrimination and speech recognition scores using the ACE™ speech algorithm.

The threshold level is defined as the lowest current level that elicits a very soft, but consistent, hearing sensation. The comfort level can be defined as the maximum current level that does not produce an uncomfortable loudness sensation for the individual. Electric threshold and comfort levels may vary as a result of stimulus waveform, electrode configuration

and placement or neural density and distribution (5). The range between the threshold and comfort levels for each electrode is known as the electrode's operating range or dynamic range. It was first stated by Simmons et al. (6) that the dynamic range may be an indicator of the number or distribution of neurons excited by the electrical stimulation.

The Nucleus™ 24 implant system, with the Contour or TRACE electrode, has a telemetry facility, which can be used to measure electrode impedance. These impedance measurements are commonly used in clinical situations to identify short or open-circuit electrodes. Electrode impedance is related to the resistive characteristics of the fluid and tissue surrounding the electrode as well as the electrode size and the chemical properties of the electrode–fluid transition. Electrode impedance is an important aspect in the development of new electrode arrays, because it is the major factor determining the power consumption (7). With the current trend towards smaller behind-the-ear speech processors, power consumption is a critical factor in the design of CI systems.

Audiological tests, such as phoneme discrimination and speech recognition scores (8), are commonly used to assess the auditory performance of CI subjects.

## MATERIAL AND METHODS

### Patients

The procedures followed were in accordance with the ethical standards of the responsible committee on human experimentation and with the Helsinki Declaration of 1975, as revised in 1983. The study design

\* Present address: The Eargroup, Antwerp-Deurne, Belgium.

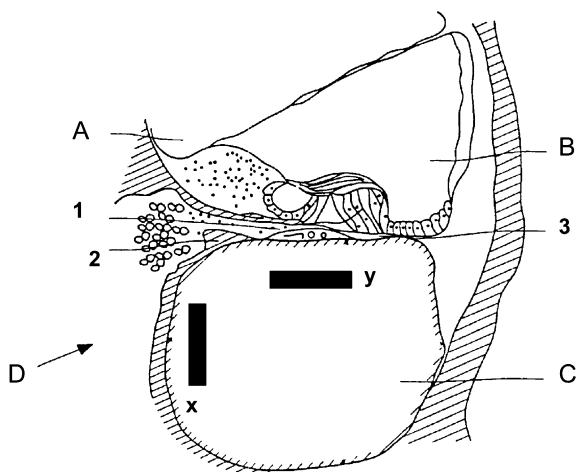

Fig. 1. Cross-sectional view of the scala tympani (C) modified after Hatshushika et al. (4), showing the scala vestibuli (A), scala media (B) and modiolus (D). Between the scala tympani and the scala media can be seen the habenula perforata (1), osseous spiral lamina (2) and basilar membrane (3). The positions of the electrode contacts of the Nucleus Contour and TRACE electrodes are indicated with x and y, respectively.

was approved by the Ethical Committee of St Augustinus Hospital.

#### Threshold and comfort levels

We used charge-balanced biphasic pulses with a phase width (PW) of 25  $\mu$ s and an inter-phase gap (IPG) of 8  $\mu$ s (Fig. 2). The stimulus train duration was 500 ms with a pulse rate of 720 pulses/s. Threshold (T) and comfort (C) levels were measured in the monopolar stimulation mode, in which the extra-cochlear electrode contacts are used as the return electrodes.

An ascending adaptive procedure (7) was employed for T-level determination. This consists of the presentation of a single pulse train in two current level (CL) steps up and five CL steps down, until a point is reached at which the patient responds to two con-

secutive presentations within one CL variation. For the C-level measurements, ascending in two CL steps was done until the patient reported that the comfort level had been reached (7).

The T- and C-level data shown were all obtained 3 months after the first switch-on of the implant. The threshold data for all individual electrode contacts were averaged over each individual TRACE subject, and so were the C-level data. The data for the new electrode were compared with the normal value for a group of 56 subjects with a Nucleus Contour electrode (Royal Victorian Eye and Ear Hospital, Melbourne, Vic.).

#### Impedance measurements

Electrode impedances were measured in the monopolar stimulation mode using the clinical WinDPS software (R116) 3 months after switch-on. A detailed description of the technique was given previously (9, 10). The biphasic current pulses used in this experiment had phases of equal duration (25  $\mu$ s PW), with an IPG of 8  $\mu$ s. The stimulus train duration was 500 ms. The measurements presented were all performed 3 months after the first switch-on of the implant with a current level of 100 CL ( $\approx$  85  $\mu$ A). Impedance data for each individual electrode contact were averaged over each individual subject. The 3-month data for the new electrode were compared with the normal value for a group of 159 subjects with a Nucleus Contour electrode (Royal Victorian Eye and Ear Hospital).

#### Phoneme discrimination scores

The phoneme discrimination test (8) is an oddity test in which phonemes are presented and the subject is asked to react to the odd phoneme, allowing an analytical interpretation. A basic set of seven phoneme pairs was used: /u/-/a/, /l/-/a/, /u/-/l/, /m/-/z/, /v/-/z/, /z/-/s/, /s/-/sh/. The "phoneme discrimination score" (APE<sup>®</sup>) is the number of correctly discriminated phonemes. The loudness level and duration of all phonemes were the same in order to ensure that the discrimination could only be based on spectral differences. The test was performed in a soundproof room. During the test the subject heard a repeated phoneme, the so-called "background phoneme", with a stimulus interval of 850 ms, which was suddenly replaced by another phoneme, the "stimulus phoneme" or "odd phoneme". All test sessions began with a training phase during which the subject was trained to react to the odd phoneme (8).

The basic set of phonemes was presented to the subject using a standard ACE speech strategy with a monopolar stimulation mode, 3 months after switch-on. The absolute scores were summarized in a box-and-whisker plot and compared to 30 CI patients with

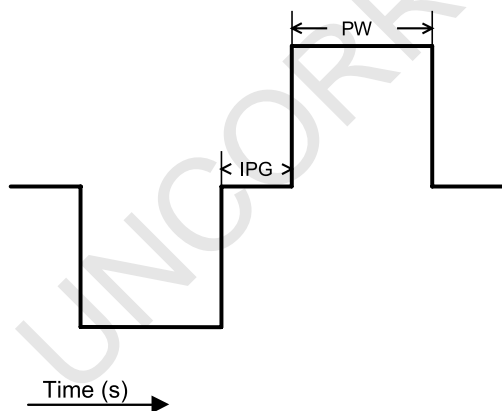

Fig. 2. Schematic representation of a biphasic current pulse, showing the PW and IPG.

a standard Nucleus Contour implant at the St Augustinus Hospital, Antwerp by means of a Mann–Whitney U-test.

### Speech recognition scores

We used consonant–vowel–consonant (CVC) words in the speech recognition test. The CVC words were part of the Flemish recordings of the NVA list (11). The NVA list consists of sublists of 12 Flemish monosyllables, spoken by a male voice. All words are balanced in rms SPL. In this study, 1 sublist was presented each time, at levels of 55, 60, 65, 70 and 75 dB SPL in the monopolar ACE stimulation mode. The response to the first word in each sublist was not included in the analysis. The maximum phoneme scores for the monopolar ACE strategy were measured 3 months after switch-on and summarized in a box-and-whisker plot. The values were compared to the maximum scores of 30 standard Nucleus Contour implant wearers at the St Augustinus Hospital by means of a Mann–Whitney U-test.

## RESULTS

### T and C levels in comparison to the reference Nucleus Contour electrode

Three-month T data for the Nucleus Contour electrode are presented in a distribution curve in Fig. 3 (mean  $\pm$ SD  $139 \pm 21$  CLs;  $n = 56$ ). Individual T data for nine patients with the new electrode are also shown. Three-month C data for the Nucleus Contour electrode are presented in a distribution curve in Fig. 4 (mean  $\pm$ SD  $178 \pm 21$  CLs;  $n = 56$ ). Individual T data for nine patients with the new electrode are also shown.

### Impedance measurements

Three-month post-switch-on impedance data for the Nucleus Contour electrode are presented in a distribution curve in Fig. 5 (mean  $\pm$ SD  $6.63 \pm 1.7$  k $\Omega$ ;  $n =$

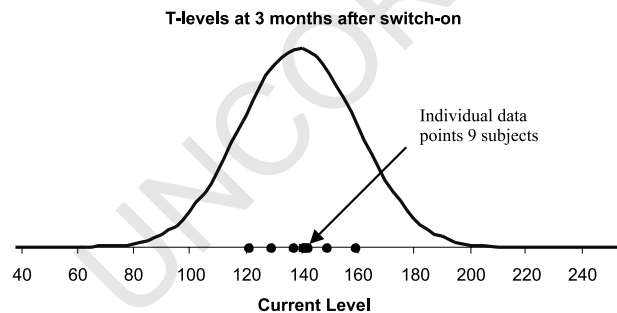

Fig. 3. Distribution curve of the T-level values of the Nucleus Contour electrode, together with the nine individual values for the TRACE electrode.

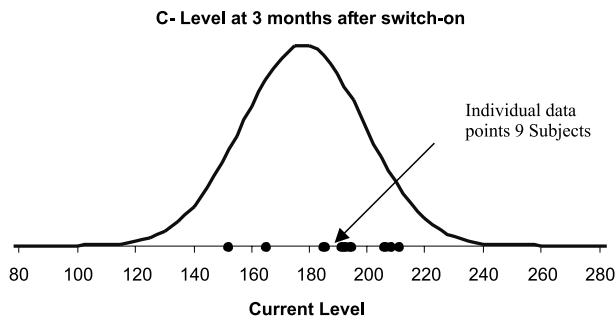

Fig. 4. Distribution curve of the C-level values of the Nucleus Contour electrode, together with the nine individual values for the TRACE electrode.

156). Individual impedance data for nine patients with the new electrode are also shown.

### Phoneme discrimination scores

Fig. 6 shows the phoneme discrimination scores for 9 TRACE patients and 30 standard Nucleus Contour patients 3 months after the first fitting. There was no statistically significant difference between the scores for the two groups ( $p > 0.05$ ).

### Speech recognition scores

Fig. 7 shows the NVA maximum phoneme scores for 9 TRACE patients and 30 standard Nucleus Contour patients 3 months after the first fitting. There was no statistically significant difference between the scores for the two groups ( $p > 0.05$ ).

## DISCUSSION

When a new CI electrode array has been implanted in an initial trial subject group, the main question that should be asked during the trial is whether the electrode can be implanted in a larger subject group. To answer this question, fitting and evaluation parameters for the new electrode can be compared to those for a standard, commonly used, clinical electrode. In

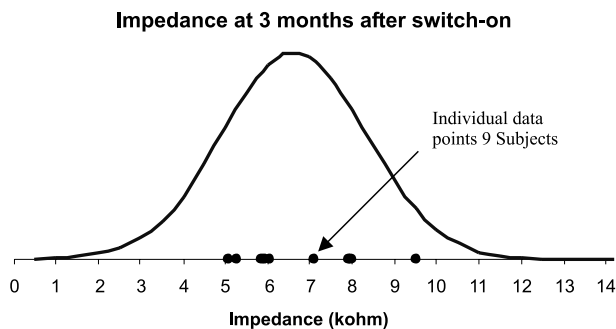

Fig. 5. Distribution curve of the impedance values of the Nucleus Contour electrode, together with the nine individual values for the TRACE electrode.

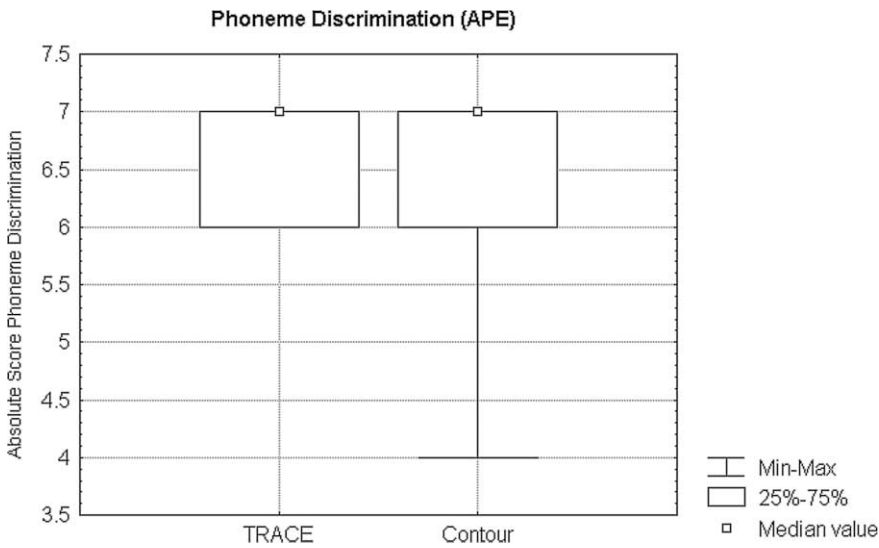

Fig. 6. Box-and-whisker plot of the phoneme discrimination scores of the 9 TRACE subjects compared to 30 CI subjects implanted with the standard Nucleus Contour electrode.

the initial trial described in this paper, the newly designed TRACE electrode was compared to the standard, commonly used, Nucleus Contour electrode. The electrode contacts of both electrode arrays have an active surface of  $\approx 0.300 \text{ mm}^2$ . The main difference between the two electrodes is the position of the metal electrode contacts in the scala tympani (Fig. 1). The Nucleus Contour electrode is designed to have stimulation contacts focused to the modiolus, where the TRACE electrode has contacts focused to the basilar membrane. When looking at the T- and C-level data for the nine TRACE subjects, we can conclude that these values fall within the normal range for the Nucleus Contour electrode reference group. When using monopolar stimulation, the posi-

tion of the contacts in the scala tympani is not a significant cause of difference in this limited group. The impedance values measured in the monopolar mode equally fall within the same range.

We also compared the phoneme discrimination and speech recognition scores for both groups of subjects after 3 months of processor use. The 3-month scores provide a good indication of final CI performance, as most improvement occurs during the first 2–3 months. After performing a Mann–Whitney U-test on both sets of data we did not find a significant difference between the two subject groups. This means that within the limited group of TRACE subjects the scores are within the same range as those for the standard Nucleus Contour CI.

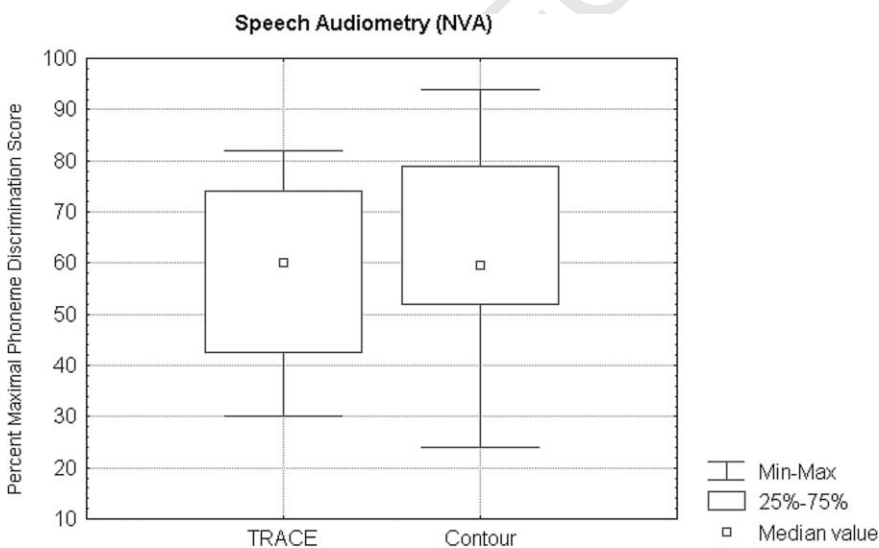

Fig. 7. Box-and-whisker plot of the speech recognition scores of the 9 TRACE subjects compared to 30 CI subjects implanted with the standard Nucleus Contour electrode.

## CONCLUSION

The standard fitting parameters and audiological scores for the newly designed TRACE electrode do not differ significantly from those in the standard Nucleus Contour dataset.

## REFERENCES

1. Frijns JH, de Snoo SL, Schoonhoven R. Potential distributions and neural excitation patterns in a rotationally symmetric model of the electrically stimulated cochlea. *Hear Res* 1995; 87: 170–86.
2. Chatterjee M, Shannon RV. Forward masked excitation patterns in multi electrode electrical stimulation. *J Acoust Soc Am* 1998; 103: 2565–72.
3. Deman PR, Kaiser TM, Dirckx JJ, Offeciers FE, Peeters SA. Design, construction and mechanical optimisation process of electrode with radial current flow in the scala tympani. *J Neurosci Methods* 2003; 128: 143–50.
4. Hatsushika S, Shepherd RK, Clark GM, Tong YC, Funaska S. Dimensions of the scala tympani in the human and cat with reference to cochlear implants. *Ann Otol Rhinol Laryngol* 1990; 99: 871–6.
5. Helmerich LF, Edgerton BJ. Psychoelectric measurements and results from cochlear implant patients. *Ann Otol Rhinol Laryngol Suppl* 1982; 91: 35–40.
6. Simmons FB, Walker MG, Mathews RG, White RL. Percepts and discrimination by auditory nerve stimulation: a summary of results and some proposals for nerve variability evaluation. In: McPherson DL, ed. *Advances in prosthetic devices for the deaf: a technical workshop*. Rochester, NY: National Institute for the Deaf, 1978: 271–4.
7. Saunders E, Cohen L, Aschendorff A, Shapiro W, Knight M, Stecker M, et al. Threshold, comfortable level and impedance changes as a function of electrode-modiolar distance. *Ear Hear* 2002; 23: 28–40.
8. Govaerts PJ. Congenital sensorineural hearing loss, a contribution to its detection, diagnosis and treatment [PhD dissertation]. Antwerp, Belgium: Medical Sciences, University of Antwerp, 2002.
9. Swanson B, Seligman P, Carter P. Impedance measurements of the Nucleus 22-electrode in patients. *Ann Otol Rhinol Laryngol Suppl* 1995; 166: 141–4.
10. De Ceulaer G, Johnson S, Yperman M, Daemers K, Offeciers FE, O'Donoghue GM, et al. Long-term evaluation of the effect of intracochlear steroid deposition on electrode impedance in cochlear implant patients. *Otol Neurotol* 2003; 24: 769–74.
11. Bosman A. Speech perception by the hearing impaired [PhD thesis]. Utrecht, The Netherlands: University of Utrecht, 1989.

*Submitted July 9, 2003; accepted November 6, 2003*

Address for correspondence:

Paul J. Govaerts, MD, MSc, PhD  
The Eargroup  
Herentalsebaan 75  
B-2100 Antwerp-Deurne  
Belgium  
Tel.: +32 33 14 13 00  
Fax: +32 33 14 03 79  
E-mail: dr.Govaerts@eargroup.net